

# **CITY THEATRICAL**

**NEW YORK • LONDON**

## **QolorPoint® Wireless LED Uplighter User's Manual**

Rev 2.0



© 2022 City Theatrical, Inc.

**US HEADQUARTERS  
475 BARELL AVENUE  
CARLSTADT, NEW JERSEY 07072  
TEL 800 230 9497 / 201 549 1160  
FAX 201 549 1161**

**[www.citytheatrical.com](http://www.citytheatrical.com)**

**LONDON OFFICE  
UNIT 1-3 WYVERN ESTATE, BEVERLEY WAY  
NEW MALDEN, SURREY KT3 4PH  
TEL +44 (0) 20 8949 5051  
FAX +44 (0) 20 7183 6061**

## Contents

Disclaimer.....	2
Product Modification .....	3
Radio Compliance Information.....	3
5792M Multiverse Radio CE Declaration of Conformity .....	4
System Compliance Information .....	6
Safety Notices .....	6
Introduction.....	7
QolorPoint Wireless Uplighter features.....	7
Product Contents .....	8
Charging.....	8
User Interface.....	9
Power .....	9
External Power (Optional Accessory) .....	9
Function Modes.....	10
Cust Col Mode Operation .....	10
Static Mode Operation .....	11
DMX Mode Operation .....	12
Built-In Effects .....	13
SHow ID Settings, Multiverse and RDM.....	14
SHow ID LED .....	14
Additional Settings.....	15
Power Mode .....	15
Brightness Control.....	15
PWM Frequency Control.....	15
Keypad Lock .....	16
Mechanical .....	16
Locking.....	16
Dimensions .....	17
Warranty.....	18

## Disclaimer

City Theatrical Inc. believes the information in this manual is accurate and complete however assumes no responsibility for any error or omissions within this document or any other documentation accompanying the product. We reserve the right to revise this document at any time. Please see <http://www.citytheatrical.com> to download latest version.

## Product Modification

This City Theatrical product has been designed and manufactured to meet the strict requirements of U.S., EU and International safety regulations. Any unauthorized modifications to the product including replacement of parts with non-standard parts could compromise safety and result in the product being non-compliant with relevant standards.

**There are no user serviceable parts within this product.**

## Radio Compliance Information

**5995 Multiverse® Module 2.4GHz Radio without internal antenna**

**FCC ID: VU65792M**

**IC: 7480A-5792M**

### FCC Compliance Statement (United States)

This device complies with Part 15 of the Federal Communications Commission (FCC) Rules. Operation is subject to the following two conditions:

1. This device may not cause harmful interference.
2. This device must accept any interference received, including interference that may cause undesired operation.

**CAUTION:** Changes or modifications to this unit not expressly approved by the party responsible for compliance could void the user's authority to operate this equipment.

### IC Statement

This device complies with Industry Canada's license-exempt RSSs. Operation is subject to the following two conditions:

1. This device may not cause interference; and
2. This device must accept any interference, including interference that may cause undesired operation of the device.

Le présent appareil est conforme aux CNR d'Industrie Canada applicables aux appareils radio exempts de licence. L'exploitation est autorisée aux deux conditions suivantes:

1. l'appareil ne doit pas produire de brouillage, et
2. l'utilisateur de l'appareil doit accepter tout brouillage radioélectrique subi, même si le brouillage est susceptible d'en compromettre le fonctionnement.

## System Compliance Information



The 7000 QolorPoint Wireless LED Uplighter is CE Certified

City Theatrical Incorporated declares that this product conforms to the specifications listed in this manual.

Restrictions on Hazardous Substances (RoHS) (2011/65/UE)

Electromagnetic Compatibility (2004/108/CE).

Technical requirements for radio equipment. (RED Directive of EU 2014/53/EU)

Standards Applied:

EN 301 489-1:v2.1.1(2017), EN 301 489-18:v3.1.1(2016), EN 300 328:v2.1.1(2016)

BS EN 60598-1:2008, BS EN60598-2-4:1998

EN 55022/A1:2007, EN61000-6-3, EN61000-3-2, EN61000-3-3, EN61000-6-1

*CAUTION—This equipment is intended to be used in all EU and EFTA countries.*

*Outdoor use may be restricted to certain frequencies and/or may require a license for operation. Contact local Authority for procedure to follow.*

## WEEE & RoHS Statement



The European Directive 2011/65/UE on Waste Electrical and Electronic Equipment (WEEE), requires that products must not be disposed of the normal unsorted municipal waste stream. Appliances must be collected separately in order to optimize the recovery and recycling of the materials they contain and reduce the impact on human health and the environment.

The consumer must contact their local authority or retailer for information concerning disposal of their products.

City Theatrical provides a take-back facility for batteries used within City Theatrical products, although the expense for transport remains the liability of the consumer. Please contact City Theatrical directly if this service is required.

## Safety Notices

Please read this entire manual before using your new equipment. Please keep the manual in a safe place so you can refer to it in the future as required.

The QolorPoint wireless LED uplighter is intended for use only by qualified professionals. Connection, installation and hanging of this equipment must be performed in accordance with all pertinent local, regional and national safety codes and regulations.

Be sure installation provides adequate ventilation. Some system components can produce significant heat and must be properly installed to allow proper cooling and assure user safety. All sides of the equipment must be clear of obstruction and allow free airflow.

There are no user-serviceable parts inside! Refer to qualified service personnel!

**RF Exposure:** The antenna(s) used for this transmitter must be installed to provide a separation distance of at least 8" (20cm) from all persons and must not be collocated or operating in conjunction with any other antenna or transmitter.

- AVOID direct eye exposure to the light source when illuminated
- DO NOT submerge this product in water
- DO NOT hang this product other than by the means indicated in this manual
- DO NOT leave any flammable material near product while operating or charging
- ALWAYS use the supplied charger or charging case
- ALWAYS ensure the charger is connected to the specified voltage
- ALWAYS ensure the charging case lid is open whilst plugged into mains supply
- NEVER connect this product or charger to a dimmer pack
- DO NOT operate this fixture if it appears damaged in any way
- DO NOT operate this fixture where the ambient temperature exceeds 115°F (45°C )

In the unlikely event that your product develops a fault, please contact your local dealer or authorized distributor. Do not attempt to repair yourself unless specifically instructed by City Theatrical Inc.

**Note: Restrictions apply to transporting this equipment on aircraft due to the lithium polymer batteries having capacity greater than 100Wh. Please consult IATA Packing Instructions 967 and City Theatrical Inc. for further information.**

## Introduction

The City Theatrical QolorPoint fixture is a battery-powered wireless uplighter capable of providing portable and instant architectural and feature lighting anywhere. With high-powered red, green, blue and white LEDs the fixture is capable of producing any color or shade of white using combinations of those LEDs. Ideal for illuminating buildings in color, both indoors and outdoors, the fixture is powerful enough to light buildings of 3 or 4 stories. Lighting effects may be created in three ways:

- By using the built in static colors or stand alone routines in each QolorPoint fixture
- By designating one fixture as a Master and using its built in Multiverse wireless DMX transceiver to broadcast to a group of QolorPoint fixtures set in Slave Mode.
- By broadcasting to a group of QolorPoint fixtures by using an external lighting console and a Multiverse wireless DMX transmitter such as Multiverse SHoW Baby or Multiverse Node.

**NOTE:** A RDM controller such as DMXcat® CAT# 6000 and a DMX cable adapter CAT# 7008 is required to set a SHoW ID usable with the Multiverse transmitters CAT#s 5910 & 5911

## QolorPoint Wireless Uplighter features

- Very Fast setup and break-down
- IP65 Outdoor rated
- Will light three stories using four high brightness LED quad chips including white- 2000 lumen output
- Even color mixing and easy white pastel shades using four color Cree LEDs (RGB+W)
- Recharge under four hours using Li-Ion Battery
- Built-in Multiverse wireless DMX 2.4GHz technology
- Available six way charging flight case (only 50Kg, 110 lbs.)
- Battery life exceeding 10 hours on maximum output dual color or cycle
- Cylindrical shape with removable stainless shroud
- Variable PWM for TV and Video applications
- Head tilts up to 45 degrees both directions
- Lightweight- 10lbs. per unit
- High powered 2000 lumen RGBW LEDs equivalent to 5300 Lux @ 6.5ft (2m)
- LEE Filter Color Library (70 choices) or separate RGBW control. Plus built-in color programs.
- Multiverse wireless DMX Master + Slave control (2.4GHz)

- Cable DMX output of full universe– unit acts as a wireless DMX receiver to cable DMX converter
- Four or five Channel DMX operation
- Intuitive LCD menu
- Operating temperature range -4°F to 113°F (-20°C to +45°C)

**Product Contents**

**Charging case of six units**

- 6x QolorPoint Wireless LED fixtures
- 6x Stainless steel shroud
- 1x Charging case
- 1x Powercon Cable
- 1x Quickstart guide



**(Silver Shroud)**



**(Silver Shroud Removed)**



**(User Interface)**

## Charging

The battery charger may be included as an accessory for individually purchased fixtures or built into the flight case for multiple charging fixtures. In each case the supply has an input voltage range of 100-240 VAC at 50/60Hz.

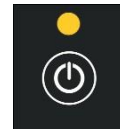
Ensure the product is used only with correct voltage and frequency of mains supply.

Never connect the charger or charging case to a dimmer circuit, even when a dimmer has been configured for 'non-dim' or 'switched' operation.

- **Turn the unit OFF** before connecting to the charger
  - When the QolorPoint is properly seated in the case, it will automatically power down.
  - Older units may have to be turned off manually.
- Never close the lid during charging; this allows escape of heat
- Only use the supplied charger or charging case
- External chargers should be plugged into the six-pin connector on the front of the unit
- For best results recharge battery fully before storage
- Switch off the charger unit and unplug once fully charged
- While charging the LED indicator will illuminate in AMBER
- Once fully charged the LED indicator will show GREEN

**DO NOT use any charger other than the unit supplied with the QolorPoint.**

The Charging Status light starts as Red, when requiring charge, and fades to green (becoming orange while charging) when charged.



Charging



Charged

**When using a charging flight case, ensure the unit is pushed fully down on the charging connector and the protruding screws are located in their positioning holes. Rotate the fixture slightly until it drops into these positioning holes. The charge light on top of the unit should illuminate to signify this has been done.**

## User Interface



Power

- Push and hold this power button for >1 second to switch the unit ON or OFF
- The display will show "CTI by Core" and the software version for a few seconds before starting
- The display backlight will turn off after 20 seconds to reduce power use

This six-button pad is the main control interface for the QolorPoint Wireless Uplighter. The button functions are SHOW ID, FUNCTION, DOWN, UP, ENTER, and POWER.



### External Power (Optional Accessory)








An optional QolorPoint AC power supply adapter CAT# 7024 is available as an accessory to drive the QolorPoint from mains voltage 100-250VAC 50/60Hz.

- Connect this to the charging/power port in the front of the unit.
- The device supplies 24VDC to the QolorPoint which replaces battery power.
- Once connected to the Power Supply the battery disconnects and will not charge or discharge.

### Function Modes

There are four modes of Operation, accessed through the **FUNCTION** menu;

<b>Custom Color</b>	This mode allows the fixture to output a static Red, Green, Blue or White color, or any combination thereof; each color may be set to any value 0 to 255. Any DMX signal, if present, is ignored.
<b>Static</b>	In this mode the fixture outputs a static LEE or preset 'cc' or Custom Color as selected.  All settings are remembered when the unit is turned off and on. If the light was turned on when powered down the fixture will remember the last state and restore it once powered back on. (This is true for Custom Color, Static, and Effects)  Any DMX signal, if present, is ignored.
<b>DMX</b>	In this mode the fixture is under control of DMX and may be controlled by a Multiverse DMX compatible device or a Master fixture. The options available within DMX mode are described in more detail below.
<b>Effects</b>	In this mode the fixture generates a number of special effects. The speed of effect types can be adjusted from 1 to 10.

To change Function press . Use the   buttons to select "CHANGE Function" and press  to accept. Then use the   buttons to select the required function as seen above and press .


The four modes of operation are discussed in more detail below.



All of these adjust the brightness settings for each color.

### Custom Color Mode Operation

#### Custom Colors

When in Custom Color mode, the display indicates the current selected color

Simply press  to step through the colors or accept a color value.

Use   keys to change the value.

Value range 0 to 255.

Tip: Mix red & blue for purple/pink

Tip: Mix red & green for orange/yellow

Tip: Mix red & green with White for warm shades of white.






## Static Mode Operation



### Static operation

When in STATIC mode the display indicates the current selected color.

To change the current selected color press .

The last character of the currently selected color is underlined.

Use the   keys to select a color from the built-in library of 70 pre-programmed colors, including 60 popular LEE Filter Colors

The color changes when cycling through the available options. The selected color is only saved when  is pressed. If  is not pressed, the color reverts to the previously selected color after 8 seconds.


### Available colors



<b>cc001</b>	White	<b>Lee075</b>	Evening Blue	<b>Lee157</b>	Pink
<b>cc002</b>	Half Flesh Tone	<b>Lee089</b>	Moss Green	<b>Lee159</b>	No Color Straw
<b>cc003</b>	Full Flesh Tone	<b>Lee100</b>	Spring Yellow	<b>Lee162</b>	Bastard Amber
<b>cc004</b>	Half Mint Green	<b>Lee101</b>	Yellow	<b>Lee170</b>	Deep Lavender
<b>cc005</b>	Mint Green	<b>Lee102</b>	Light Amber	<b>Lee174</b>	Dark Steel Blue
<b>cc006</b>	Half Ice Blue	<b>Lee103</b>	Straw	<b>Lee181</b>	Congo Blue
<b>cc007</b>	Full Ice Blue	<b>Lee104</b>	Deep Amber	<b>Lee192</b>	Flesh Pink
<b>cc008</b>	Soft Red	<b>Lee106</b>	Primary Red	<b>Lee199</b>	Regal Blue
<b>cc009</b>	Soft Green	<b>Lee107</b>	Light Rose	<b>Lee323</b>	Jade
<b>cc010</b>	Soft Blue	<b>Lee108</b>	English Rose	<b>Lee341</b>	Plum
		<b>Lee113</b>	Magenta	<b>Lee345</b>	Fuchsia
<b>Lee002</b>	Rose Pink	<b>Lee115</b>	Peacock Blue	<b>Lee353</b>	Lighter Blue
<b>Lee009</b>	Pale Amber Gold	<b>Lee117</b>	Steel Blue	<b>Lee652</b>	Urban Sodium
<b>Lee010</b>	Medium Yellow	<b>Lee118</b>	Light Blue	<b>Lee722</b>	Bray Blue
<b>Lee013</b>	Straw Tint	<b>Lee119</b>	Dark Blue	<b>Lee724</b>	Ocean Blue
<b>Lee015</b>	Deep Straw	<b>Lee121</b>	Lee Green	<b>Lee738</b>	Jazz Green
<b>Lee017</b>	Surprise Peach	<b>Lee126</b>	Mauve	<b>Lee765</b>	Lee Yellow
<b>Lee019</b>	Fire	<b>Lee127</b>	Smoky Pink	<b>Lee776</b>	Nectarine
<b>Lee020</b>	Medium Amber	<b>Lee135</b>	Deep Amber Gold	<b>Lee777</b>	Rust

<b>Lee024</b>	Scarlet	<b>Lee136</b>	Pale Lavender	<b>Lee779</b>	Bastard Pink
<b>Lee026</b>	Bright Red	<b>Lee138</b>	Pale Green	<b>Lee789</b>	Blood Red
<b>Lee046</b>	Dark Magenta	<b>Lee139</b>	Primary Green	<b>Lee793</b>	Vanity Fair
<b>Lee058</b>	Lavender	<b>Lee147</b>	Apricot	<b>Lee795</b>	Magical Magenta
<b>Lee068</b>	Sky Blue	<b>Lee153</b>	Pale Salmon		

## DMX Mode Operation

### DMX Operation

When in DMX mode the display indicates the current DMX address. To change the current selected DMX address press .

Use the   keys to select a DMX address. To access the Multiverse SHoW IDs, you must use an RDM device such as, a DMXCat. Here is the order of screens seen in DMX Mode:

- 'Change DMX Mode'
- 'sDMX Slave'
- 'sDMX Master'
- 'DMXCable Slave'
- 'DMXCable to sDMX'





SHoW ID light will turn off when 'DMXCable Slave' is selected.

City Theatrical QolorPoint is equipped with a Multiverse wireless radio transmitter and receiver and all NEO SHoW IDs. This allows the fixture color to be set up by or synchronized with sequences produced by a DMX lighting controller or other QolorPoint unit when in Receive, or SLAVE mode.

Alternatively, when in MASTER mode, the unit can be linked to many Slave units which will then duplicate everything output from the Master. Master QolorPoint fixture settings must be as follows:

- Function Static, Custom, or Effect DMX Modes DMX Master
- All Slave fixtures must be in the same SHoW ID as the Master

If not using a QolorPoint as a Master unit then a compatible Multiverse transmitter attached to a DMX controller is necessary, available separately.

To select the DMX function, Press the FN  button, use arrows   to toggle to Change Function DMX, toggle to Function DMX, and enter .



Once DMX function has been chosen the main screen will show the DMX address.

To change the DMX mode press FN , use up and down arrows   to select Change DMX Mode, and enter .



**DMX Master Operation**

Once Master mode is set, the Master may transmit to any number of slaves by selecting a matching SHoW ID using the SHoW ID button or by using an RDM device such as a DMXcat.

**DMX Slave Operation**

When in DMX Slave mode the display will show the current active DMX Start Address so the unit can be controlled from a DMX controller or master.




The number of channels occupied is dependent on the ***“DMX MODE”*** setting (4 or 5 channels may be used by the fixture).


In this mode the entire universe is output on a side connector pin, for which a connector cable is available from City Theatrical Inc. for connection to other non-wireless fixtures.

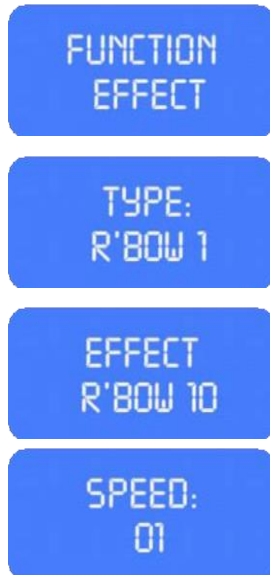
## Built-In Effects

The QolorPoint is now equipped to generate a number of special effects as a stand-alone unit when DMX is placed in Slave Mode or will output these to a number of connected slave units when DMX is in Master Mode.

By pressing the  button the last used effect type is brought up, which can then be changed using the   buttons.

By pressing the  button to confirm the effect type, the speed can be adjusted from a range 1 to 10 using the   buttons.

When confirmed with the  button the screen reverts to show the effect and speed.




## DMX Mode



The QolorPoint has 2 modes of operation.

From the “**CHANGE Settings**” menu select the “**5<sup>th</sup> DMX CHANNEL**” option as follows:

Mode	Chan	Function	Notes
5 <sup>th</sup> CHAN Off	1	Red	This mode disables master dimmer. Each of the color values may be set from 0 to 255.
	2	Green	
	3	Blue	
	4	White	
5 <sup>th</sup> CHAN M. Fader	1	Red	This mode enables the fixture’s overall color, set on channels 1 to 4, to be dimmed. Values are 0 to 255, where 255 represents 100% output.
	2	Green	
	3	Blue	
	4	White	
	5	Dimmer (0-100%)	

## DMX Start Address

To set the DMX start address press the  button when the display shows the current address on the home screen.

Use the   buttons to select the new start address then the  to confirm.

## SHoW ID Settings

The QolorPoint uplighter uses the Multiverse 2.4GHz Radio Module. This Module is backwards compatible with SHoW DMX Neo systems. The front panel button “SHoW ID” is programmed with six SHoW Neo ID options. The

SHoW ID can be changed by pressing the SHoW ID button on the control panel of the QolorPoint Uplighter. To access the additional SHoW DMX Neo or Multiverse IDs an RDM controller is necessary as described below.

**NOTE: QolorPoint Fixtures shipped before 1/1/2022 were shipped with SHoW DMX Neo with Max Technology Radio Modules and are limited to the six IDs in the chart below.**

Color	SHoW ID	Description
Green	201	Neo Adaptive
Cyan	102	Neo Full Bandwidth
Magenta	117	Neo Low Limited Bandwidth
White	133	Neo Mid Limited Bandwidth
Red	149	Neo High Limited Bandwidth
Yellow	165	MAX Technology™

For QolorPoint Slave units to communicate with the Master QolorPoint units or a lighting control desk, equipped with a Multiverse or SHoW DMX Neo transmitting device connected to its DMX output, the SHoW ID LED color has to be the same, or the SHoW ID set via RDM has to be the same.

### Choosing additional SHoW IDs

Besides the six SHoW IDs settable via the “SHoW ID” button on the front panel, all SHoW DMX Neo SHoW IDs (70) and all Multiverse 2.4GHz SHoW IDs (147) are accessible with any RDM controller, such as DMXcat®. When set to a SHoW ID not listed in above chart, the ID/Data LED will become blue.

To access these additional IDs, you will need an RDM controller such as DMXcat CAT# 6000 and either the DMX cable adapter CAT# 7008 or a Multiverse transmitting device such as a Multiverse Baby CAT# 5900 or Multiverse Node CAT# 5902.

Using Multiverse SHoW IDs enables the use of additional Multiverse features such as Forward Error Correction, mDMX (lower radio energy), and improved RDM performance, as well as allowing the QolorPoint fixture to serve as a receiver on a system with a Multiverse Transmitter or Multiverse Node. **(Note: QolorPoint is compatible with Multiverse Transmitter P/Ns 5910 and 5911 when used with a Multiverse SHoW ID on the 2.4GHz band.)** See page 17 for more information about the additional Multiverse SHoW IDs.

Using an RDM controller like a DMXcat allows access the Multiverse Radio module settings:

- **SHoW ID**  
All available Multiverse or SHoW DMX Neo SHoW IDs can be entered here. Default is 201.
- **Output Power**  
Output power may be user selected as Low, Med, Hi, or Maximum. It is a best practice to use the least amount of output power to achieve a successful show. This helps to reduce reflections which can reduce signal fidelity and to reduce any potential negative effect on other radio users in the area. You can monitor signal strength via RDM. Default is Maximum.
- **RDM Traffic**  
The RDM Traffic setting determines whether RDM data is passed downstream of the fixture. It does not affect whether the Multiverse fixture is detectable by devices upstream. It is recommended that RDM be turned off before production situations as many DMX devices do not

correctly handle RDM data and may exhibit flickering or other undesired behavior. Default is Off.

- **SHoW Key Security** (Multiverse SHoW IDs only)

The SHoW Key setting allows a user to enter a key to privatize their SHoW ID from another system on the same SHoW ID. SHoW IDs and SHoW Keys need to match in order for receivers and transmitters to talk to each other. Keeping your SHoW Key private will provide a level of security to your Multiverse system from unauthorized use. It is not recommended to use different SHoW Keys in a system that uses multiple Multiverse Transmitters on the same SHoW ID. The range is 0 (Default) to 500.

Situation		Condition	Outcome
Same SHoW Key	with	Different SHoW IDs	OK
Different SHoW Keys	with	Same SHoW IDs	Not OK
Different SHoW Keys	with	Different SHoW IDs	OK

- **Forward Error Correction** (Multiverse SHoW IDs only)

High noise environments can affect wireless DMX performance. Enabling Error Correction adds additional information to the data packets to correct errors in slot data that would have otherwise been lost, restoring DMX delivery back to near perfect levels. The extra data reduces the number of slots that can be transported, Max reduces slots by 50%, Med by 33%, Min by 25%. Only needs to be set at the Transmitter or master fixture. Default is Off.

- **mDMX** (Multiverse SHoW IDs only)

Improves fidelity while dramatically reducing radio energy broadcast into the spectrum. Only needs to be set at the Transmitter. Default is on.

### SHoW ID LED

The SHoW ID LED color signifies the SHoW ID it is set to and indicates presence of DMX data.

Note: When RDM SHoW ID is set, the color turns Deep Blue.

The preprogrammed SHoW DMX Neo SHoW ID LED colors are noted in the SHoW ID chart on page 13.



### Description for operation in Slave mode:

If the LED is FLASHING, the QolorPoint is not receiving DMX from a Transmitter or master fixture.

If the LED is STEADILY ILLUMINATED the QolorPoint is connected with and receiving DMX from a transmitter. This is a fully connected and a fully functioning system.

### Configuring with SHoW ID Transmitter unit or QolorPoint Master unit






- Switch on the QolorPoint
- Set one unit to Master Mode and other units to Slave Mode
- Set the SHoW IDs on both Slave and Master to the same ID.
- Units will automatically connect when set to the same ID (this can take a few seconds)

For successful connection the receiver must fulfill the following conditions:

- Distance to transmitter (outdoors, and depending on conditions)
  - Less than 1,500ft. for SHoW Baby or Multiverse Transmitter
- Distance between Master unit and Slave unit
  - Less than 300ft
- Position above obstacles (e.g., crowds and trees)
  - Minimum 3ft

SHoW ID configuration between Slave and Master is remembered after power off or the battery is depleted. This allows the system configuration to be set up in a warehouse and the whole system simply switched on at the site, which makes deployment very simple.

## Change Settings

To change Settings press . Use the  buttons to select “CHANGE Settings” and press  to accept. Then use the  buttons to select the additional settings and press .

The additional setting options are Power Mode, Brightens Control, and operations are discussed in more detail below.



### Power Mode

QolorPoint has two power modes that can be selected:

<b>Power LongLife</b>	50% Power
<b>Power Normal</b>	Full Power

The “Normal” option provides maximum light output at the cost of reduced battery life. “LongLife” reduces the LED output by 50%, therefore enables 2 x running period for ALL FUNCTIONS, whether stand-alone or DMX.




To change the power mode press  and use the  buttons to select “**CHANGE Settings**” then press . Use the  buttons to select “**POWER MODE**” and press  to select.

Use  buttons to toggle between “Norm” and “LongLife” then press  to save changes. This setting affects all Static, Custom Color and DMX modes so that the battery life of each unit can be individually set, irrespective of what’s controlling it.



### Brightness Control

Under the “**CHANGE Settings**” menu QolorPoint has a separate brightness control that can control the output of the unit in stand-alone mode:

The value may be changed from 0 to 100% in 1% increments:

Press  and use the  buttons to select “**CHANGE Settings**” then press  to accept.




Use the  buttons to select “**BRIGHTNS CONTROL**” and press  to select.


Use  buttons to toggle between “0%” and “100%” then press  to save changes. This setting brightens control and adjusts all modes.

## PWM Frequency Control

For HD TV work QolorPoint is equipped with an option to adjust the PWM frequency of the LEDs to prevent 'beating' with the TV scan frequency.


To enable soft dimming press  and use the   buttons to select "**CHANGE Settings**" then press  to select.


Then use the   buttons to select "**PWM Freq**" and press  to select from value 488Hz to 3.9kHz.


Press  to save changes and the screen will revert to showing the 'Function' mode.

## Keypad Lock

The keypad may be locked to prevent tampering or inadvertent adjustment of the unit.

Hold down the  first then turn on, after a couple seconds, release the buttons. The screen will indicate if the unit is locked or unlocked.

To Lock: Hold down the  while switching ON the unit to Lock.

To Unlock: First switch OFF the unit. Hold down the  while switching ON the unit to Unlock.

## Mechanical

### Locking

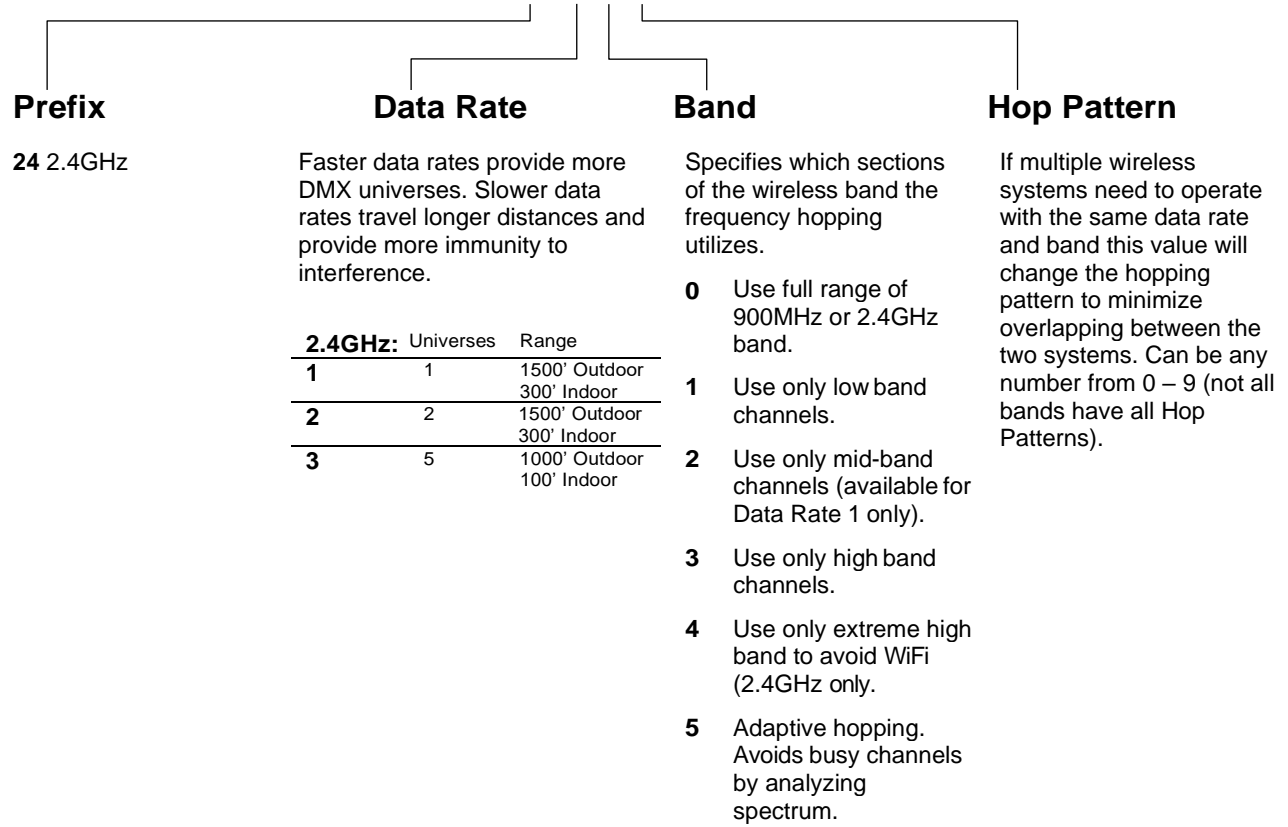
The unit may be locked to a nearby object by passing a locking wire or padlock through the locking holes in the top or bottom plates.

A Kensington Lock point (shown on the unit's diagram) is also provided on the bridle assembly holding the head in place.

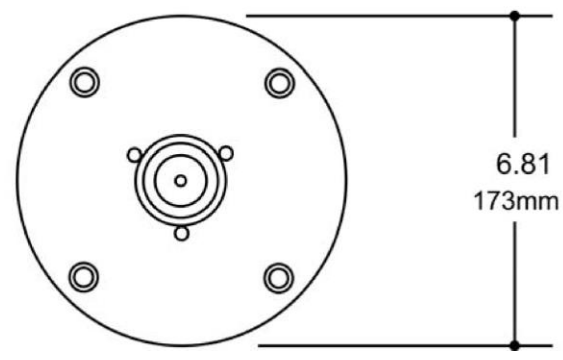
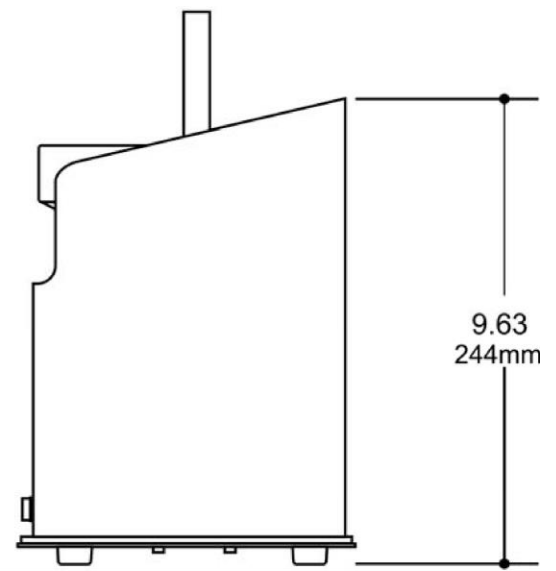
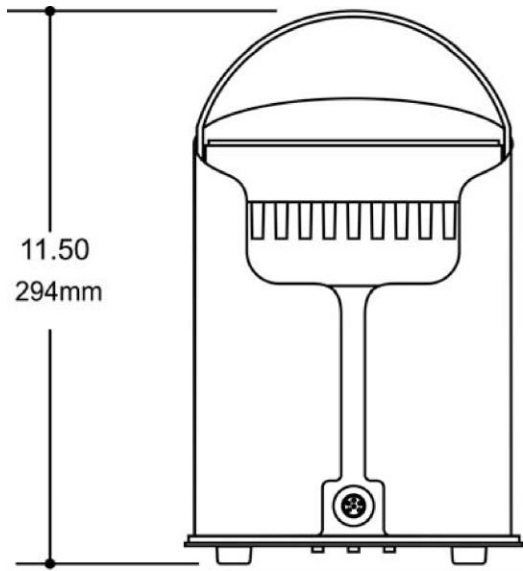


Table 1: Multiverse SHoW IDs

Multiverse SHoW ID Example: **24302**



Note: Not all combinations of digits are possible and unused numbers are reserved for future use.



## Warranty

City Theatrical Incorporated (City Theatrical) warrants this product to be free from defects in materials and workmanship (subject to the terms set forth below).

City Theatrical will repair or replace (at City Theatrical's option) this product or any defective parts in this product. The standard warranty period is 12 months from date of purchase, although this period may vary from country to country. If in doubt consult your dealer and ensure that you retain proof of purchase.

To obtain warranty service, please contact the City Theatrical authorized dealer from which you purchased this product. If your dealer is not equipped to perform the repair of your City Theatrical product, it can be returned directly to City Theatrical, with carriage being paid at your own expense. You will need to ship this product in either its original packaging or packaging affording an equal degree of protection. Providing the product is found to be faulty, City Theatrical will pay for return carriage.

Proof of purchase in the form of a bill of sale or receipted invoice, which is evidence that this product is within the warranty period, must be presented to obtain warranty service.

This Warranty is invalid if (a) the factory-applied serial number has been altered or removed from this product or (b) this product was not purchased from a City Theatrical authorized dealer.

This Warranty does not cover cosmetic damage or damage due to acts of God, accident, misuse, abuse, negligence, or modification of, or to any part of, the product. This Warranty does not cover damage due to improper operation, maintenance or installation, or attempted repair by anyone other than City Theatrical or a City Theatrical dealer, or authorized service agent which is authorized to do City Theatrical warranty work. Any unauthorized repairs will void this Warranty. This Warranty does not cover products sold AS IS or WITH ALL FAULTS.

REPAIRS OR REPLACEMENTS AS PROVIDED UNDER THIS WARRANTY ARE THE EXCLUSIVE REMEDY OF THE CONSUMER. CITY THEATRICAL SHALL NOT BE LIABLE FOR ANY INCIDENTAL OR CONSEQUENTIAL DAMAGES FOR BREACH OF ANY EXPRESS OR IMPLIED WARRANTY IN THIS PRODUCT. EXCEPT TO THE EXTENT PROHIBITED BY LAW, THIS WARRANTY IS EXCLUSIVE AND IN LIEU OF ALL OTHER EXPRESS AND IMPLIED WARRANTIES WHATSOEVER INCLUDING, BUT NOT LIMITED TO, THE WARRANTY OF MERCHANTABILITY AND FITNESS FOR A PRACTICAL PURPOSE.

For any service, in or out of warranty, please contact your dealer.