

**QolorFLEX® HiQ High CRI LED Tape, 6000K**  
**2835-24-H6000-120-5-20-1**

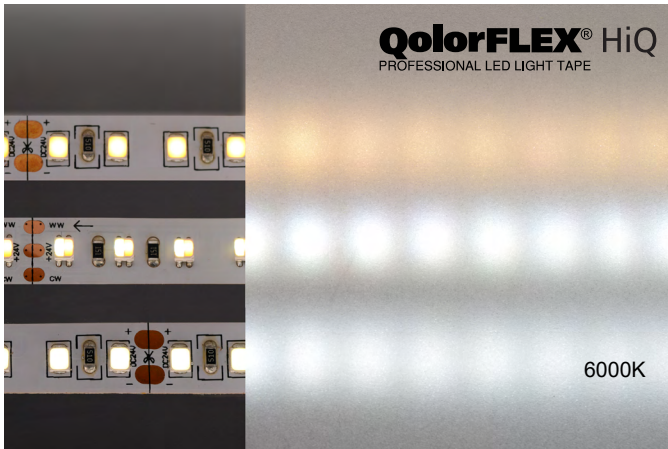

**QolorFLEX HiQ High CRI LED Tape, 6000K** was designed to have a Color Rendering Index (CRI) of 95+, making it an ideal high CRI LED tape for the needs of the film industry. **QolorFLEX HiQ High CRI LED Tape** offers exceptional on-camera color rendition and allows lighting professionals to match the light sources already being used on their set. It is available in three color temperatures: 3200K, **6000K**, and 2700-6500K. Like all 40+ types of QolorFLEX LED Tape, **QolorFLEX HiQ High CRI LED Tape** is sold in 5m reels and includes six-inch long pigtails on both ends for easy connections to QolorFLEX Dimmers for flicker-free dimming.

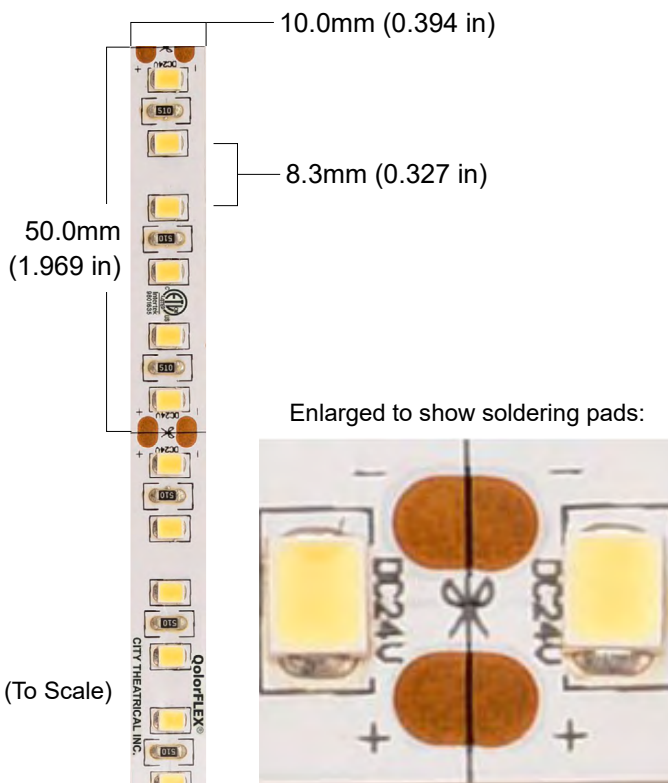

**SPECIFICATIONS:**

Physical		
Length	5m	(16.404 ft)
Width	10mm	(0.394 in)
Cutting Increment	50mm	(1.969 in)
LED Spacing	8.3mm	(0.327 in)
Backing Color	White	
Connector Type	200mm long (7.874 in) flat cable on both ends, stripped 10mm and tinned	

Output	
Color(s)	Cool White
Color Temperature	6000K ± 200K
Beam Angle	120°
Brightness	1200 lumens/m
Color Rendering Index (CRI)	≥ 95





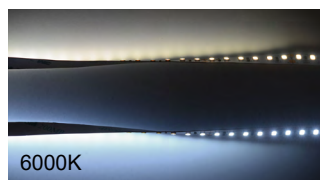

Electrical	
Operating Voltage	24VDC
Current	2600 mA/5m
Power Consumption	63 w/5m (3.8 w/ft)
Density	120 LEDs/m
LED Chip Size	2835

Product Information	
Use Environment	Indoor
Dimmable	Fully Dimmable
Average Life	50,000 hours
Warranty	Two years
IP Rating	IP20
Compliance	ETL, CE, RoHS















# QolorFLEX LED Tape Accessories





## Ribbon Cables:

P/N	NAME	
6607	Ribbon Cable, Six Conductor, 18 GA	
6607-20	Ribbon Cable, Six Conductor, 20 GA (thinner than 18 GA)	
6600	Ribbon Cable, Five Conductor, 18 GA	
6600-20	Ribbon Cable, Five Conductor, 20 GA (thinner than 18 GA)	
6608	Ribbon Cable, Four Conductor, 18 GA	
6606	Ribbon Cable, Three Conductor, 18 GA	
6605	Ribbon Cable, Two Conductor, 18 GA	

## Connectors:







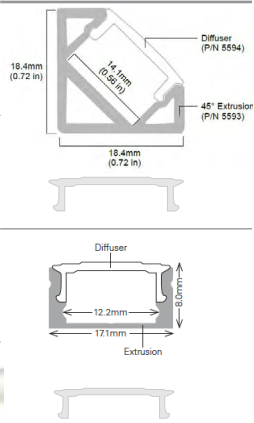



P/N	NAME	
6612	Terminal Block Connector, Six Pin, Male	
6613	Terminal Block Connector, Six Pin, Female	
6610	Terminal Block Connector, Five Pin, Male	
6611	Terminal Block Connector, Five Pin, Female	
5673	Terminal Block Connector, Four Pin Male	
5674	Terminal Block Connector, Four Pin Female	
5671	Terminal Block Connector, Three Pin Male	
5672	Terminal Block Connector, Three Pin Female	
5657	Terminal Block Connector, 2-Pin Male	
5658	Terminal Block Connector, 2-Pin Female	
6615	Female barrel to screw terminal connector	
6616	Male barrel to screw terminal connector	

## Extrusions and Diffusers:

P/N	NAME	
6693	Aluminum Extrusion, 45-Degree, 2m for 45-Degree LED Tape installations	
6694	Diffuser for 45-Degree Extrusion, 2m	
6690	Aluminum Extrusion, Low Profile, 2m	
6695	Diffuser for Low Profile Extrusion, 2m	

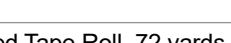

## End Caps, Tape, and Clips:

P/N	NAME	
6690-1	End Cap for 6690 Aluminum Extrusion (Pack of 10)	
6690-2	End Cap with hole for 6690 Extrusion (Pack of 10)	
6671-1	End Cap for 6693 45-Deg Extrusion (Pack Of 10)	
6671-2	End Cap with hole for 6693 45-Deg Extrusion (Pack Of 10)	
6680	Waterproof End Caps for Outdoor tapes (Packs of 10) 9mm w/ 2 holes	
6682	8mm (no holes)	
6684	12mm w/ 4 holes	
6686	12mm (no holes)	
6625	3M VHB Double Sided Tape Roll, 72 yards	
6630	Outdoor Tape Clips and Screws (Pack of 12)	
6632	Clips for 6693 45-Degree Extrusion (Metal) for LED Tape (Pack Of 12)	

## QolorFLEX Connect 10

P/N 5748



QolorFLEX Connect 10 is a practical and time saving solution for managing the multiple wire runs and numerous connections needed for large scale installations of LED tape.

Developed to complement QolorFLEX 5-in-1 LED Tape, QolorFLEX Connect 10 is a "plug-in box" that can connect up to nine runs of five, four, three, dual, or single color LED tape to a low voltage low dimmer. Each QolorFLEX Connect 10 uses 10 six position detachable Phoenix terminal block connectors to achieve a quick and well-ordered installation. QolorFLEX Connect 10 is constructed with a Nema 4 IP 20 steel enclosure, and offers a maximum current per device of 40A and maximum load per terminal of 20A.