

CITY
THEATRICAL
I N C

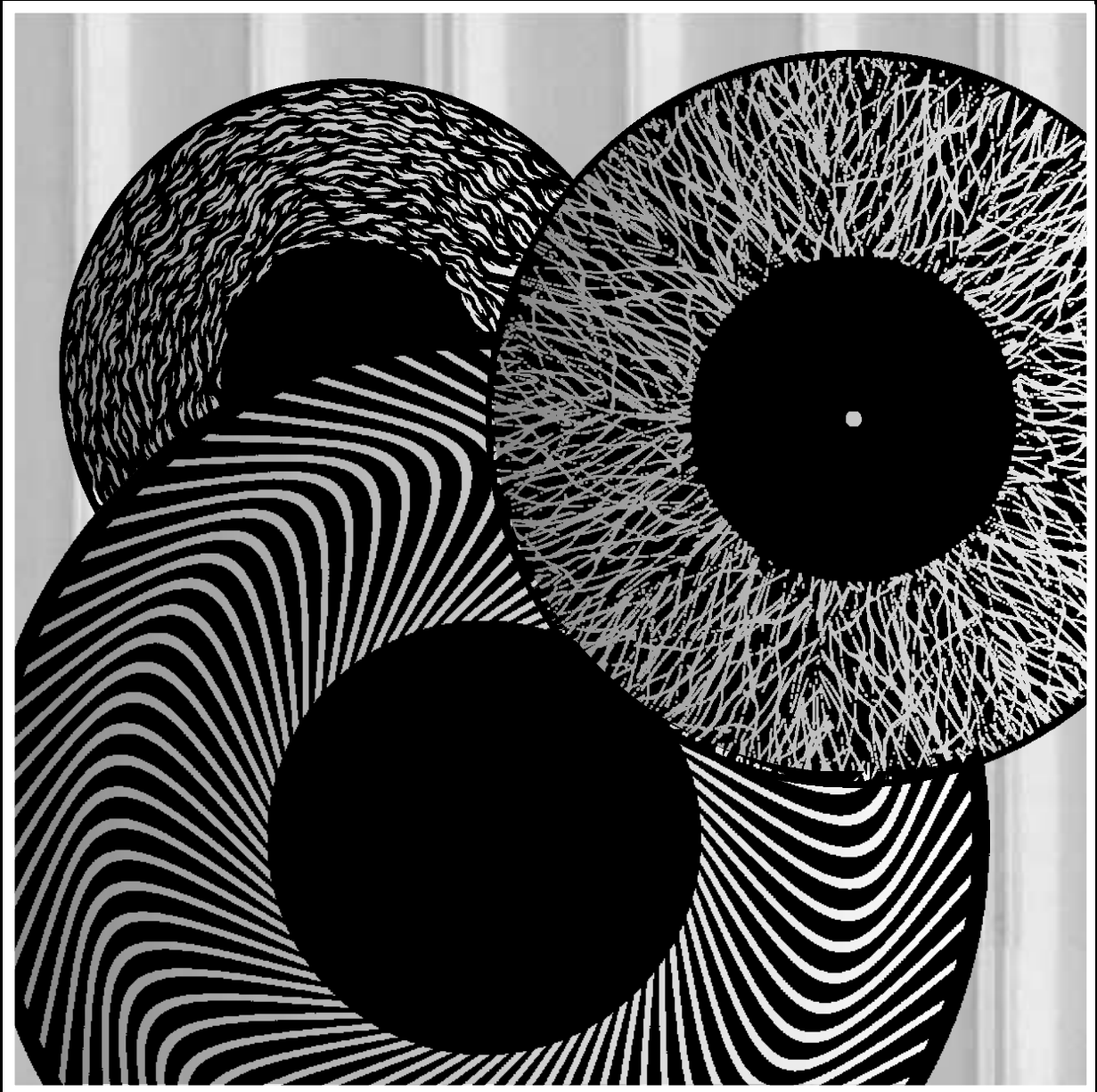

EFX PLUS ™ IDEA BOOK

752 EAST 133RD STREET . BRONX, NY 10454
718/292/7932 800/230/9497 FAX: 718/292/7482



It all begins with an idea. We've created this EFX Idea Book to help stimulate your creativity when you use our EFX Plus² effects projector. These new effects were created by lighting designers Byron Hartman, Matt Sergi, and Paul Palazzo (the inventor of the EFX) and can help you easily create hundreds of unique effects. We've grouped them by categories and have indicated the disks, direction of the disks, and the art glass to use for each effect. But don't stop there! Use your own creativity to add gel strips, static templates, and experiment with other disks and glass to create your own variations on these effects.

We know that the EFX Plus² makes a wonderful rippling water effect. Try these variations on our basic effect: Shallow Rock Stream, Bahama Shore Waves, or Underwater Ripple. For rain, try Urban Rain Storm, Rain Through Windows, Torrential Rain, or Foggy Rain. We have extended the possibilities, and you can take them even further with your own experimentation. Have fun!

We've also included all of our installation and operation instructions, technical data, specifications, and "tips and tricks" for your information. If you need any guidance in setting up your disks, assigning DMX, or fine tuning the speed of the effect, take a look at pages 16 thru 19.

Call us at 800-230-9497, or email us at efx@citytheatrical.com if you'd like to have your new ideas included in the next version of this manual.

TABLE OF CONTENTS

Effects Disks	3-4	Water	14
Art Glass	5	Paul Palazzo Effects	15
Abstract	6-8	Basic Effects	15
Clouds	9-10	Installation	16
Fire	10	Operating Instructions	17
Rain	10-12	Tips	18-19
Snow	12-13	Price List	Back cover
Stars	13		

CITY THEATRICAL I N C

752 EAST 133RD STREET • BRONX, NY 10454

Phone: 800/230/9497 718/292/7932 Fax: 718/292/7482

web: <http://www.citytheatrical.com> email: info@citytheatrical.com

Every effort is made for this book to be totally accurate. However, an occasional printing error may occur. We apologize for any inconvenience you may experience.

EFX PLUS²™

- Two planes of linear motion
- Large format pattern disks rotate in either same or opposing directions
- Variable speed control
- DMX controllable using only two channels
- Lightweight; only 8 lbs. (3.63 kg)
- Maintains use of barrel rotation
- Maintains use of template slot and shutters
- RPM Range: 0-0.7 RPM or 0-12 RPM
- Art glass slot
- EFX Plus² effects can be viewed on your computer by downloading Spinster™ software from our website
- Does not require any additional ventilation or space to use
- Comes complete with modified barrel



EFX PLUS² EFFECTS DISKS

- Large format 14" (35.56 cm) effect disks
- 21 stock patterns (check our website for new disks as they become available)
- May be used in varied combinations for striking effects
- Custom patterns available

NEW

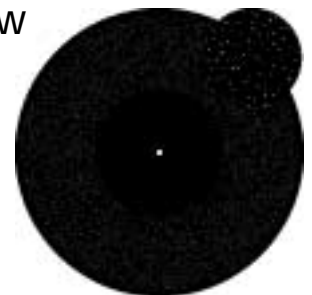

Realistic Snow
5237

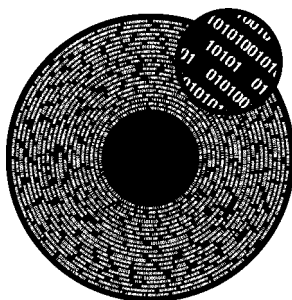

Digital Numbers
5216

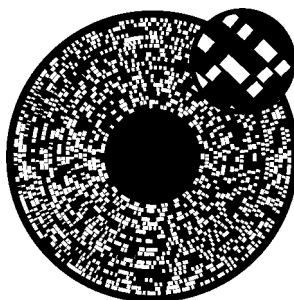

Digital Boxes
5217

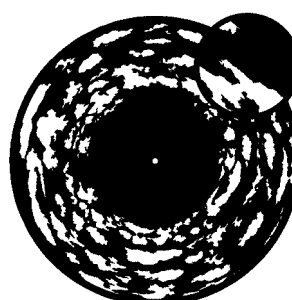

Medium Clouds
5219



Mesh Puffy Clouds
5220

EFX PLUS² EFFECTS DISKS

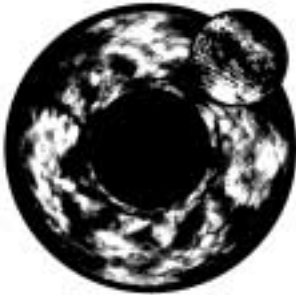

Non-Mesh Puffy Clouds
5221



Linear Clouds
5222



Fine Snow
5223

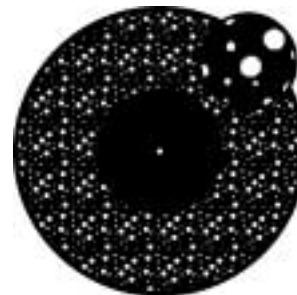

Medium Dot Breakup
5224



Water
5225

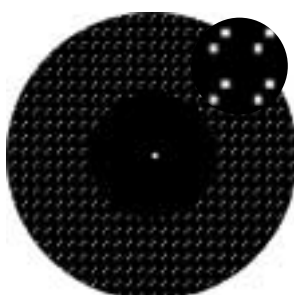

Sparse Dots
5226



Driving Rain
5227



Lobster Scope
5228



Flicker Wheel
5229



Thick Water
5230



Flames
5231



Sparse Flames
5232



Waves
5233



Rectangle Breakup
5234

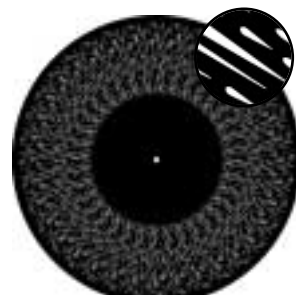

Droplet Rain
5235

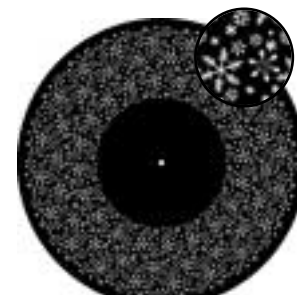

Stylistic Snow
5236

EFX PLUS² ART GLASS

- 16 stock glass patterns (check our website for new glass patterns as they become available).
- Mounts inside EFX Plus² housing

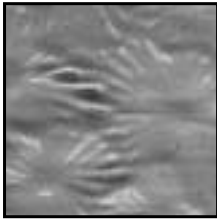

Florentine
5251

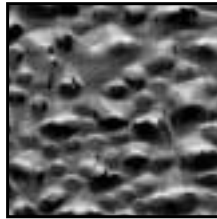

Cracked Ice
5252



Cina
5253

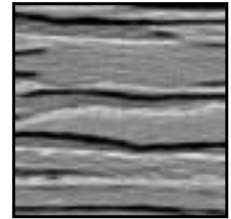

Wheat
5254



Oceanic
5255



Wavy
5256

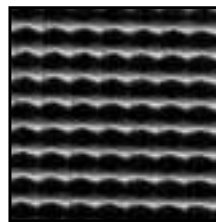

Waffle
5257

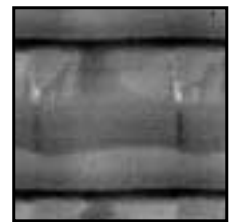

Box
5258

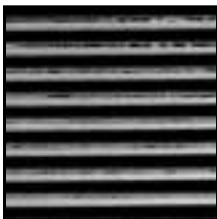

Linear
5259

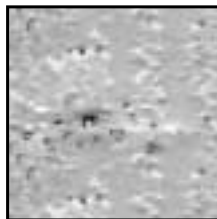

Monet
5260



Hammered
5262

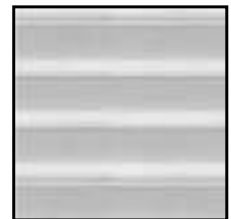

Reed
5263

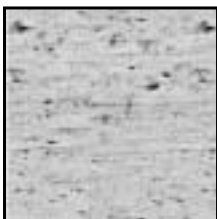

Noise
5265



Husk
5266



Snow
5280



Rain
5281

NAME/DESCRIPTION	DISK 1		DISK 2		GLASS	DIRECTION
INDISTINCT LINEAR SPARKLE I	5216	+	5216	+	5251	E
BINARY DISTORTION ABSTRACT I	5216	+	5216	+	5252	E
BINARY BLUR ABSTRACT I	5216	+	5216	+	5253	E
INDISTINCT LINEAR SPARKLE II	5216	+	5216	+	5257	E
BINARY DISTORTION ABSTRACT II	5216	+	5216	+	5255	E
BINARY BLUR ABSTRACT II	5216	+	5216	+	5256	E
INDISTINCT LINEAR SPARKLE III	5216	+	5216	+	5259	E
BINARY BLUR ABSTRACT III	5216	+	5216	+	5262	E
COMPUTER SCREENS	5216	+	5216	+	5258	E
LINED BINARY ABSTRACT	5216	+	5216	+	5263	E
BINARY STATIC ABSTRACT	5216	+	5216	+	5265	E
EXTREME BINARY BLUR ABSTRACT	5216	+	5216	+	5266	E
MATHEMATIC DREAM ABSTRACT	5216	+	5216			S
THE MATRIX ABSTRACT	5216	+	5216			O
WAVY BINARY BOX ABSTRACT	5217	+	5216	+	5256	E
BINARY BOXES ABSTRACT	5217	+	5216			E
BIG DISCO BALL	5217	+	5217	+	5258	E
TETRIS	5217	+	5217	+	5257	E
REVOLVING PLANET	5220					E
MICROSCOPIC THINGS	5221			+	5253	E
MICROSCOPIC BACTERIA	5224			+	5265	E
BUBBLES THROUGH SCOPE	5224	+	5228			E
RHINESTONE SCOPE SPARKLES	5224	+	5228	+	5255	E
DISCO BALLS	5224	+	5232	+	5257	E
TETRIS BOXES I	5226	+	5217	+	5257	E
TETRIS BOXES II	5226	+	5217			E
KALEIDOSCOPE	5226	+	5233			E
CARNIVAL	5226	+	5233			E
SHIMMER EFFECTS	5226	+	5233	+	5257	E
DISCO EFFECTS	5226	+	5233	+	5258	E
FLOWING SPARKLES	5227			+	5257	E
TIME WARP	5228	+	5229	+	5256	E
LINEAR SANDSTORM	5233	+	5233	+	5254	E
SOFT WAVES	5233	+	5233	+	5255	E
TRIPPY WAVES I	5233	+	5233	+	5253	E

NAME/DESCRIPTION	DISK 1		DISK 2		GLASS	DIREC TION
TRIPPY WAVES II	5233	+	5233	+	5256	E
BOXED VERTIGO WAVES	5233	+	5233	+	5257	E
VERTIGO WAVE SCREENS	5233	+	5233	+	5258	E
VERTIGO WAVES WITH LINES	5233	+	5233	+	5259	E
LINED VERTIGO WAVES	5233	+	5233	+	5263	E
WAVES WITH BUBBLES	5233	+	5233	+	5265	E
SANDSTORM	5233	+	5233	+	5266	E
TRIPPY WAVES III	5233	+	5233			E
CONFETTI	5234	+	5217			E
URBAN ABSTRACT	5234	+	5217			E
HAMMERED RHINESTONE	5234	+	5217	+	5262	E
TILED RHINESTONE	5234	+	5217	+	5257	E
EXTREME SPARKLES abstract, fire	5235	+	5227	+	5257	O
HELL	5230	+	5232			E
SMOKE abstract, urban	5230	+	5232	+	5255	E
ABSTRACT URBAN	5217					E
BUILDINGS/WINDOWS	5217					E
NOIR SPARKLES WITH FAN clouds	5229	+	5235	+	5257	E
SHARP CLOUDS	5219					E
COTTON CLOUDS	5219			+	5265	E
HAZY DIFFUSE CLOUDS I	5219	+	5221	+	5253	E
HAZY DIFFUSE CLOUDS II	5219	+	5221	+	5256	E
CLOUDS WITH TEXTURE	5219	+	5221	+	5265	E
CLOUDS	5219	+	5221			E
DISTORTED PUFFY CLOUDS	5221			+	5256	E
ROUNDED TEXTURED CLOUDS	5221			+	5262	E
PUFFY CLOUDS	5221					E
CIRRUS WITH TEXTURE	5222			+	5265	E
MIST AROUND MOUNTAIN	5222			+	5266	E
BLENDING CIRRUS	5222	+	5222	+	5255	E
MISTY CIRRUS	5222	+	5222	+	5265	E
CIRRUS CLOUDS	5222	+	5222			E

NAME/DESCRIPTION	DISK 1		DISK 2		GLASS	DIRECTION
------------------	--------	--	--------	--	-------	-----------

clouds, water

CLOUDS REFLECTING ON WATER	5222	+	5225	+	5253	E
CLOUDS REFLECTING ON OCEAN	5222	+	5225	+	5255	E
CLOUDS REFLECTING ON DEEP WATER	5222	+	5225	+	5256	E
SUN AND CLOUDS ON WATER I	5222	+	5225	+	5257	S
GOLD SHIMMER WITH CLOUDS I	5222	+	5225	+	5258	O
CLOUDS ON WATER	5222	+	5230			E
CLOUDS ON THE OCEAN	5222	+	5230	+	5255	E
SHALLOW CREEK CLOUDS	5222	+	5230	+	5262	E
POND OR LAKE CLOUDS	5222	+	5230	+	5256	E
CREEK OR LAKE CLOUDS	5222	+	5230	+	5266	E
RAPIDS	5222	+	5230	+	5267	O
SUN AND CLOUDS ON WATER II	5222	+	5225	+	5251	S
GOLD SHIMMER WITH CLOUDS II	5222	+	5225	+	5252	O

fire

DANCING FLAMES AND SMOKE	5231	+	5221	+	5253	E
FIRE AND SMOKE	5231	+	5221	+	5256	E
HIGH DANCING FLAMES	5231	+	5221	+	5263	E
SMOKY FIRE	5231	+	5221	+	5266	E
FIRE EFFECTS	5231	+	5221			E
FLAMES UPON FLAMES	5231	+	5232			E
FIRE STORM	5231	+	5233			E

rain

RAIN THROUGH WINDOWS I	5227			+	5258	E
RAIN THROUGH WINDOWS II	5227			+	5263	E
RAIN THROUGH WINDOWS III	5227			+	5259	E
RAIN WITH TEXTURE	R5227			+	5256	E
TORRENTIAL RAIN	5227					E
WARP SPEED	5227					E
FOGGY RAIN	5235	+	5227	+	5256	O
SMEARED WINDOW RAIN	5235	+	5227	+	5257	E
RAIN THROUGH WINDOWS IV	5235	+	5227	+	5258	O
RAIN ON WET WINDOWS	5235	+	5227	+	5262	O
RAINDROP DISTORTION	5235	+	5227	+	5263	E

NAME/DESCRIPTION	DISK 1		DISK 2		GLASS	DIREC TION
RAIN THROUGH LINED WINDOWS	5235	+	5227	+	5263	O
HEAVY RAIN	5235	+	5227			O
RAIN THROUGH WINDOW WITH FAN	5229	+	5235	+	5258	E
rain, snow						
ICE STORM	5235	+	5227	+	5252	O
SPARKLES	5235	+	5227	+	5253	E
rain, urban						
NOIR RAINY STREET	5229	+	5235	+	5259	E
URBAN RAIN STORM	5229	+	5235			E
NIGHTTIME DRIVING RAIN	5234	+	5217	+	5258	E
RAIN THROUGH BLINDS	5235	+	5227	+	5259	O
DIRTY WINDOW RAIN	5235	+	5227	+	5265	O
TRAIN WITH RAIN	5229	+	5235	+	5256	E
snow						
GENTLE KALEIDOSNOW	5236	+	5236	+	5251	S
COLLIDING KALEIDOSNOW	5236	+	5236	+	5252	O
KALEIDOSNOW SPARKLES	5236	+	5236	+	5252	S
KALEIDOSNOW FAST SPARKLES	5236	+	5236	+	5253	O
STREAKED WINDOW SNOW	5236	+	5236	+	5254	S
SHIMMER SNOW I	5236	+	5236	+	5255	O
SHIMMER SNOW II	5236	+	5236	+	5263	O
SNOW DISTORTION	5236	+	5236	+	5255	S
2-WAY SNOW DISTORTION	5236	+	5236	+	5256	O
SNOW THROUGH WINDOWS	5236	+	5236	+	5258	S
BOX SNOW SPARKLES	5236	+	5236	+	5259	O
SNOW SPARKLE FANTASIA	5236	+	5236	+	5262	S
LINED WINDOW SNOW	5236	+	5236	+	5263	S
WINDOW SNOW DISTORTION	5236	+	5236	+	5264	O
SNOW BLUR FANTASIA	5236	+	5236	+	5265	S
SNOW BLUR SPARKLES	5236	+	5236	+	5266	O
WET WINDOW SNOW	5236	+	5236	+	5266	S
SPARKLING SNOW	5236	+	5236	+	5267	O
GENTLE SNOW FANTASY	5236	+	5236			S

NAME/DESCRIPTION	DISK 1		DISK 2		GLASS	DIREC TION
snow						
FAST SNOW FANTASY	5236	+	5236			O
GLACIER	5221			+	5252	E
SNOW ABSTRACT	5226	+	5217	+	5252	E
snow, urban						
URBAN SNOW	5217			+	5252	E
WET CITY LIGHTS	5217			+	5253	E
snow, stars						
SNOW AND STARS	5224	+	5232	+	5252	E
stars						
STARS	5224	+	5232	+	5262	E
urban						
TRAIN TRAVEL	5228	+	5229			E
water						
RIVER	5222	+	5230	+	5253	E
WATER EFFECT I	5222			+	5262	E
WATER EFFECT II	5231	+	5233	+	5252	E
WATER EFFECT III	5226	+	5233	+	5252	E
OCEAN SHIMMER	5231	+	5233	+	5259	E
UNDERWATER RIPPLE	5233	+	5230	+	5251	E
SHALLOW ROCKY STREAM	5233	+	5230	+	5252	E
WATER BENEATH ICE	5233	+	5230	+	5253	E
RIVER OR OCEAN	5233	+	5230	+	5255	E
RIPPLING WATER WAVES	5233	+	5230	+	5259	E
BAHAMA SHORE WAVES	5233	+	5230	+	5265	E
FLOWING WATER WAVES	5233	+	5230			S
FAST WATER WAVES	5233	+	5230			O
FLORENTINE WAVES	5233	+	5233	+	5251	E
ICY WAVES	5233	+	5233	+	5252	E
SHIMMER EFFECTS	5226	+	5233	+	5253	E

PAUL PALAZZO'S FAVORITE EFFECTS

EFFECT	DISK 1		DISK 2		ART GLASS	MOUNT	DIRECTION
Digital Curtain	5224		+		5257	horizontal	E
Deep Sea Water	5225	+	5221	+	5255	horizontal/vertical	E
Paul's Favorite Clouds	5220	+	5232			horizontal	E
Cellular	5223	+	5260			horizontal/vertical	E
TV white noise	5223	+	5223			horizontal/vertical	E
Fire	5231	+	5231	+	5254	vertical	E
Slow moving stream	5231	+	5231	+	5255	horizontal	E
Water	5225	+	5225	+	5255	vertical	E
Fantastic Snow	5237	+	5237			vertical	E

E = either O = opposing S = same

BASIC EFFECTS

EFFECT TIPS

Rippling Water

Use two Water disks (5225) or two Thick Water disks (5230) with a piece of Oceanic Art Glass (5255). Adjust the lens to a soft focus with the disks rotating against each other. Adding a piece of striped blue gel gives the effect an added shimmer.

Reflective Water

Use two Flame disks (5231) with a piece of Husk Art Glass (5266). The two disks can rotate in the same direction, one slower than the other. Have the Husk glass's lines run in the same direction as the flame patterns. Then use some type of linear gobo (we recommend Lee GB414-Aurora Borealis) in the template slot to add some more dimension to the effect.

Rain

Use one Driving Rain disk (5227) and one Sparse Dots disk (5226) with the Rain Art Glass (5281). The Rain glass and the Driving Rain disk should be lined up parallel to each other, not perpendicular. The effect is achieved by focusing on the Rain glass and using the Driving Rain and Sparse Dots to speed up the force of the rain.

Smoke

Use the same effect set up mentioned for the Reflective Water effect, with the barrel turned 90° to allow the effect to spin upward.

Fire

Use two Flame disks (5231) with a piece of Wheat Art Glass (5254) and the barrel turned 90°. A linear static gobo, like GAM 546 (Rabble) or Rosco 402 (Linear2) adds to the effect. A striped gel of red and yellow gives the flames extra kinetic effect.

Roaring Fire

Use one Flame disk (5231) and one Thick Water disk (5230) with a piece of Oceanic Art Glass (5255). Turn the barrel 90° and bring the Flame disk to a soft focus. The disks should turn in the same direction, the Thick Water disk a little faster than the Flame disk. The result is a licking, roaring fire.

Clouds

Use two Non-Mesh Puffy Clouds disks (5221) with a piece of Cina Art Glass (5253). The cloud disks should move in the same direction, one slightly slower than the other. To help cut the slight arcing in the clouds, shutter off the very edges of the image field or use a static cloud gobo in the template slot.

INSTALLATION INSTRUCTIONS

PARTS IDENTIFICATION LIST

1. Motor Housing
2. EFX Back Cover
3. EFX Disk/s
4. ETC Source Four or Strand SL Front Barrel Assembly (modified)
5. DMX ports
6. Fan
7. Fan Switch
8. Upper Hub
9. Center Shaft
10. Lower Hub
11. Upper Hub Set Screw
12. EFX Disk Mounting Screw
13. L-Bracket
14. Safety Cable Assembly
15. Art Glass Slot Retaining Clips

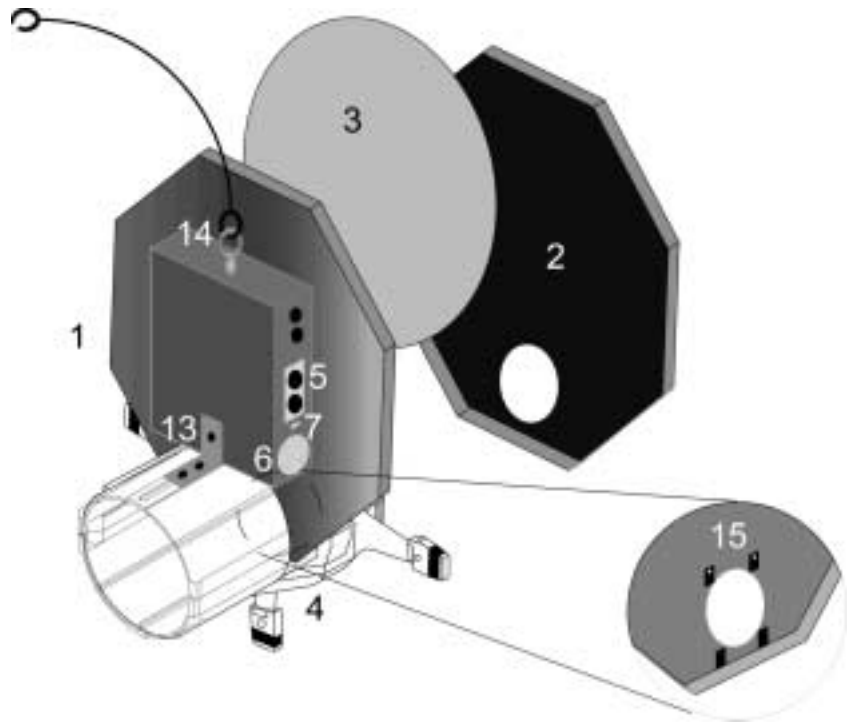

TOOLS REQUIRED

1. Phillips head screwdriver
2. Small slotted screwdriver
3. Pliers

UNIT SET-UP INSTRUCTIONS

- Place the unit motor side down on a flat surface with the projection opening toward you.
- Unscrew the four (4) small Phillips head screws (6-32 x 1/4") on the perimeter of the EFX Back Cover (#2) and remove the Back Cover.
- Remove the upper hub (#8) from the center shaft (#9) of the unit by loosening the set screw (#11) on the side of the shaft with a small slotted screw driver.
- Art Glass can be installed in the EFX if desired. Art Glass can be installed on the EFX Motor Housing cover(#1) by using the retaining slips (#15). Loosen the two (2) nuts that secure the retaining clips for the Art Glass. Slide the glass into the fixed retaining clips. Once the glass is in place, reposition the top two (2) retaining clips over the glass, tightening the nuts, locking the glass in place.
- Remove the two (2) EFX disk mounting screws (4-40 x 1/4") from the Lower Hub. Place EFX Disk 2 down over the corresponding mounting holes and replace both screws.
- Replace the Upper Hub on the Center Shaft making sure to align the set screw to the flat side of the shaft. Tighten set screw with a screw driver. The EFX Disk 1 attaches to the Upper Hub the same way as the Lower Hub.
- **Note:** The EFX can run with only one EFX disk, but the upper Hub (#8) must still be attached and locked to the Center Shaft (#9).
- Replace the Back Cover. Replace and tighten the four (4) Phillips head screws.

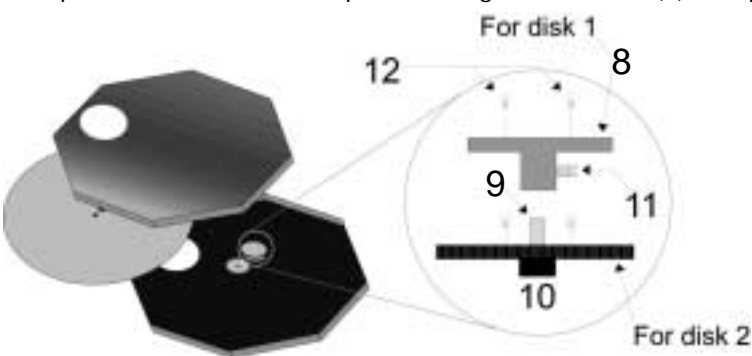

- Insert the unit into the modified ETC Source Four or Strand SL barrel with the registration pins riding outside the modified slot. Screw the motor casing (using 8-32 x 1/2") into the provided L-bracket.

Warning: Do not operate the EFX Plus² without the L-bracket attached. Attach the safety cable to the EFX through the eye hook located on top of the Motor Housing (#1).

- Address the unit as necessary (See addressing information).
- Plug in the unit, DMX, and AC power. If DMX is present the gears will turn slightly and then stop.

OPERATING INSTRUCTIONS

DMX ADDRESSING

- Switch #1 = 1
- Switch #2 = 2
- Switch #3 = 4
- Switch #4 = 8
- Switch #5 = 16
- Switch #6 = 32
- Switch #7 = 64
- Switch #8 = 128
- Switch #9 = 256
- Switch #10 = Stand-Alone Mode

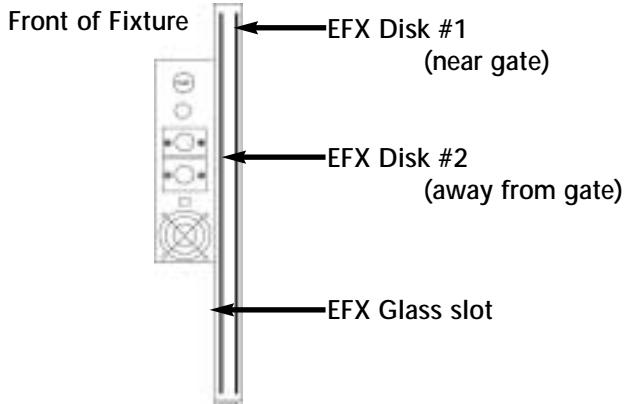

ADDRESSING INFORMATION

In the window of the Motor Housing you will find a 10-position dip switch bank. This bank of switches will allow the assignment of DMX locations 1 to 512. When the starting address is assigned, the next channel is automatically set as the next control channel sequence. Each switch in the 10-switch bank has a value assigned to it when it is in the "On" position; the value for the switches in the "Off" position is 0.

To set the address, place the switches that add up to the desired starting address in the "On" position. For example, if your starting address is 398, you would first switch on the 9th switch (256), then switch the 8th switch (128), then the 4th switch (8), the 3rd switch (4), and the 2nd switch (2) to the "On" positions; all other switches should remain "Off". **The address will only be activated after the EFX unit is powered down and then powered back up. This will cause a circuit reset.**

DMX CONTROL - Direction and speed of front-projected image (directions are indicated as viewed from the audience).

- | | | |
|--------|-----------|---|
| 1. DMX | 0% | Stationary |
| | 1% | Fastest clock-wise speed |
| | 2% - 44% | Slowing from Fast to Stop in clockwise direction |
| | 45% - 55% | Stationary |
| | 56% - 99% | Speeding up from Slow to Fastest in counter-clockwise direction |
| | FL (100%) | Fastest counter-clockwise speed |

STAND-ALONE MODE

Stand-Alone Mode allows speed and direction settings to be set and changed without running DMX to the unit. In Stand-Alone Mode (Dip switch #10 in the "On" position), switches #1-#4 control EFX Disk 1 and switches #5-#8 control EFX Disk 2. Switch #9 is not used.

DISK 1 - switch #4 sets direction

Switch	#1	#2	#3	
off	off	off	off	STOP
on	off	off	off	Slowest
off	on	off	off	↓
on	on	off	off	
off	off	on	off	
on	off	on	off	
off	on	on	off	
on	on	on	on	Fastest

DISK 2 - switch #8 sets direction

Switch	#5	#6	#7	
off	off	off	off	STOP
on	off	off	off	Slowest
off	on	off	off	↓
on	on	off	off	
off	off	on	off	
on	off	on	off	
off	on	on	off	
on	on	on	on	Fastest

FAN

The fan may be turned on or off (recessed switch located beside fan and marked). Use a small slotted screwdriver to slide the switch to either an off or on position. However, it is strongly recommended that the fan is ON during operation. If the unit is used continuously for more than 1 hour, the **FAN MUST BE TURNED ON**. Otherwise, the continuous use may cause damage to the unit.

TIPS AND TRICKS

Here are some things to try if you can't get your effect to go slow enough:

- Try changing motor directions. (You may have to turn the unit upside down to create the effect you want.)
- Write your cue to start the motor(s) faster, fade them down to your speed, and then bring up the fixture intensity. (You don't have to start at full speed; about half-speed will suffice.)
- Mount the disk to the other motor. (This will work if you are using only one disk or the other disk doesn't need to go as slow.)

The following procedures describe three methods of slowing down the effect disks of an EFX Plus2 scenic projection device: Proportional Patch, Custom Dimmer Profile, and a chase cue. Please refer to the users manual of your console for information as to how these techniques can be applied.

Using Proportional Patch:

Set the dimmer to which the EFX unit is addressed to a proportional patch of 50%. The resulting output is zero when the level is zero, but the output is now 50% when the level is set to FULL. This has the effect of doubling the resolution of the channel, which will allow for finer speed control of the EFX. This must be done for each channel that controls a disk if you want the fine control.

If you want the disk to rotate in the opposite direction, the channel must be inverted with the FLIP feature of the console. Create the proportional patch first, then invert the channel. This must be done for each channel that controls a disk to make the disk turn in the proper direction (if you have already set up the channel for proportional patch).

Verify the finer control of your EFX disks.

Using Custom Dimmer Profile:

Create a custom profile for the dimmer so that only a small range of the dimmer is used to control the EFX unit. This is similar to the proportional patch in that it gives you a finer control resolution, but the custom dimmer profile can give you even more resolution. This example sets up a profile that gives you fine speed AND direction control of the disk with the one channel. The custom dimmer profile only needs to be created once. Just patch it to the channels where you need it.

Example:

Fader Level, %	Intensity Level	Disk Behavior
0	40	Clockwise Fast
5	41	↓
10	42	
15	43	
20	44	
25	45	
30	46	
35	47	
40	48	Clockwise Slow
45	49	Stop
50	50	Stop
55	51	Stop
60	52	Counter-Clockwise Slow
65	53	↑
70	54	
75	55	
80	56	
85	57	
90	58	
95	59	
Full	60	Counter-Clockwise Fast

Verify the finer control of your EFX disks.

Using a Chase Cue:

This method involves creating a cue that runs the motor for a short time and stops the motor for a short time. The run-stop sequence is alternated with a chase effect or with linked cues. The resulting effect can produce extremely slow disk movement.

To do this:

Set up the control channels with either of the methods mentioned (Proportional Patch, or Dimmer Profile). Determine the slowest level at which the motor will operate. Write a series of linked cues that alternate the motor from run to stop. The first cue should start the motor at a faster speed than required, with a dwell of about 3-4 seconds, to insure that the motor will start. The next cue should run the motor at a level at least 1% faster than the desired slowest speed. The final cue should run the motor not less than 2% slower than the slowest speed at which the motor will operate. Link the third cue back to the second cue. Experiment with the follow times and possibly the motor levels to create the desired effect. Try an initial run time of 0.2 seconds and a stop time of 0.2 seconds. These times will vary depending on the specific mechanical conditions of each unit.

CITY
THEATRICAL
I N C

752 East 133rd Street, Bronx, NY 10454
Toll Free: (800) 230-9497
Phone: (718) 292-7932
Fax: (718) 292-7482
email: info@citytheatrical.com
web: <http://www.citytheatrical.com>



CAT. #	DESCRIPTION	LIST
EFX PLUS2^a		
5200	EFX PLUS2 FOR S4 0.7 RPM (115V)*	1,496.25
5201	EFX PLUS2 FOR S4 0.7 RPM (230V)*	1,496.25
5202	EFX PLUS2 FOR S4 12 RPM (115V)*	1,496.25
5203	EFX PLUS2 FOR S4 12 RPM (230V)*	1,496.25
* INCLUDING MODIFIED BARREL ** NOT INCLUDING MODIFIED BARREL (NOT NEEDED)		
EFX PLUS2 EFFECTS DISKS		
5215	CUSTOM METAL DISKS	441.00
5216	DIGITAL NUMBERS	126.00
5217	DIGITAL BOXES	126.00
5219	MEDIUM CLOUDS	126.00
5220	MESH PUFFY CLOUDS	126.00
5221	NON-MESH PUFFY CLOUDS	126.00
5222	LINEAR CLOUDS	126.00
5223	FINE SNOW	126.00
5224	MEDIUM DOT BREAKUP	126.00
5225	WATER	126.00
5226	SPARSE DOTS	126.00
5227	DRIVING RAIN	126.00
5228	LOBSTER SCOPE	126.00
5229	FLICKER WHEEL	126.00
5230	THICK WATER	126.00
5231	FLAMES	126.00
5232	SPARSE FLAMES	126.00
5233	WAVES	126.00
5234	RECTANGLE BREAKUP	126.00
5235	DROPLET RAIN	126.00
5236	STYLISTIC SNOW	126.00
5237	REALISTIC SNOW	126.00
EFX PLUS2 ART GLASS		
5251	FLORENTINE	26.15
5252	CRACKED ICE	26.15
5253	CINA	26.15
5254	WHEAT	26.15
5255	OCEANIC	26.15
5256	WAVY	26.15
5257	WAFFLE	26.15
5258	BOX	26.15
5259	LINEAR	26.15
5260	MONET	26.15
5262	HAMMERED	26.15
5263	REED	26.15
5265	NOISE	26.15
5266	HUSK	26.15
5280	SNOW	145.25
5281	RAIN	145.25